EAST YORKSHIRE SOLAR FARM

**East Yorkshire Solar Farm
EN010143**

Environmental Statement

**Volume 2, Appendix 13-5: Framework Construction Traffic Management Plan,
Annex B: Proposed Passing Places on East Riding of Yorkshire Council Adopted
Highways**

Document Reference: EN010143/APP/8.48

Regulation 5(2)(a)
Infrastructure Planning (Applications: Prescribed Forms and Procedure)
Regulations 2009

September 2024
Revision Number: 00

WILLITOFT RD / B1128 JUNCTION NORTH - EAST MOVEMENTS Scale - 1:1000

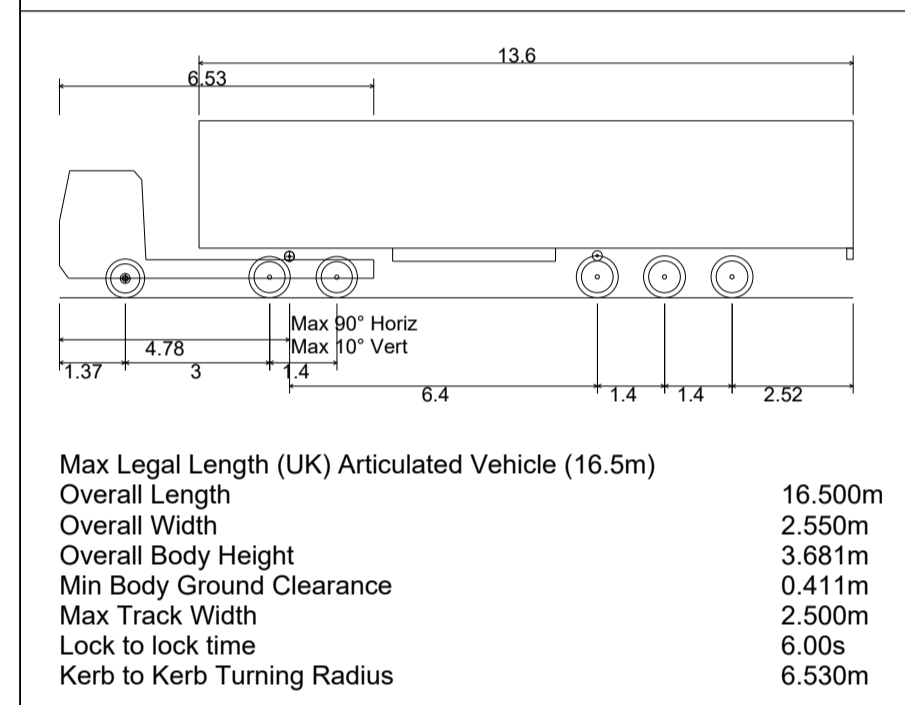
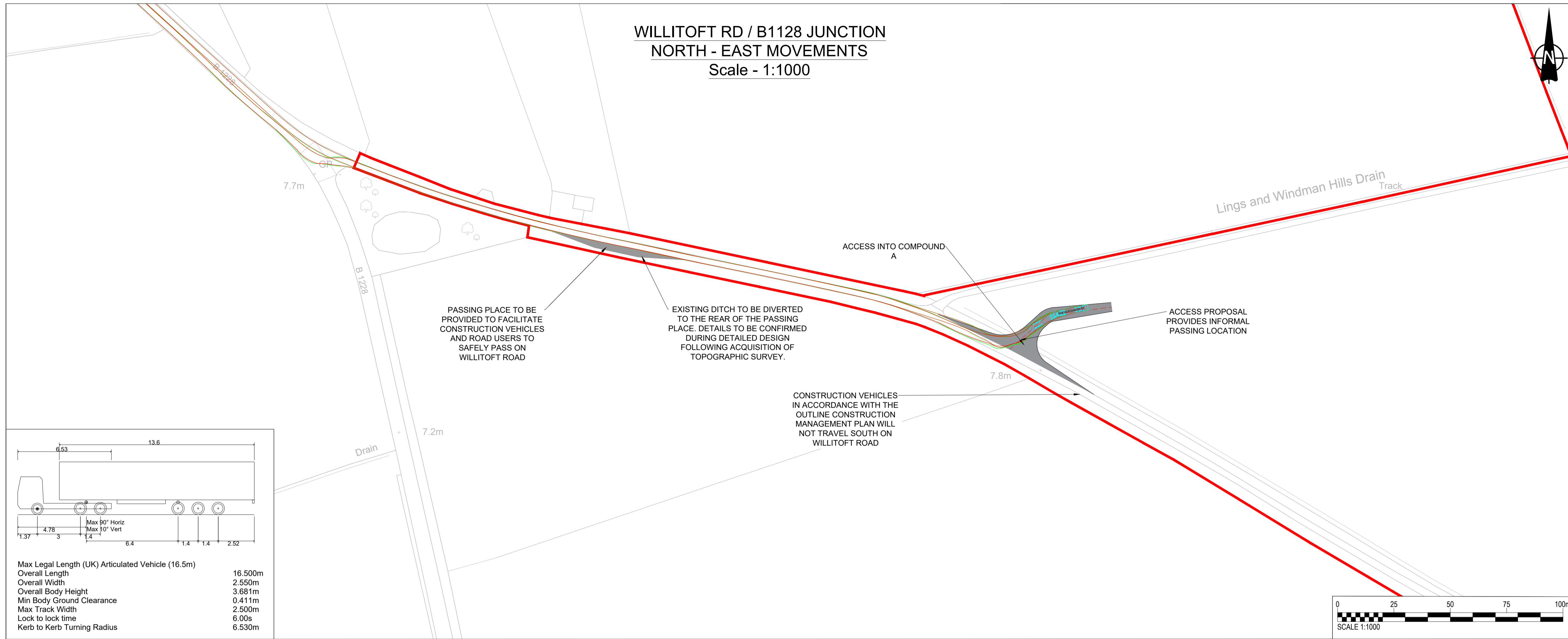

WILLITOFT RD PASSING BAY Scale - 1:500

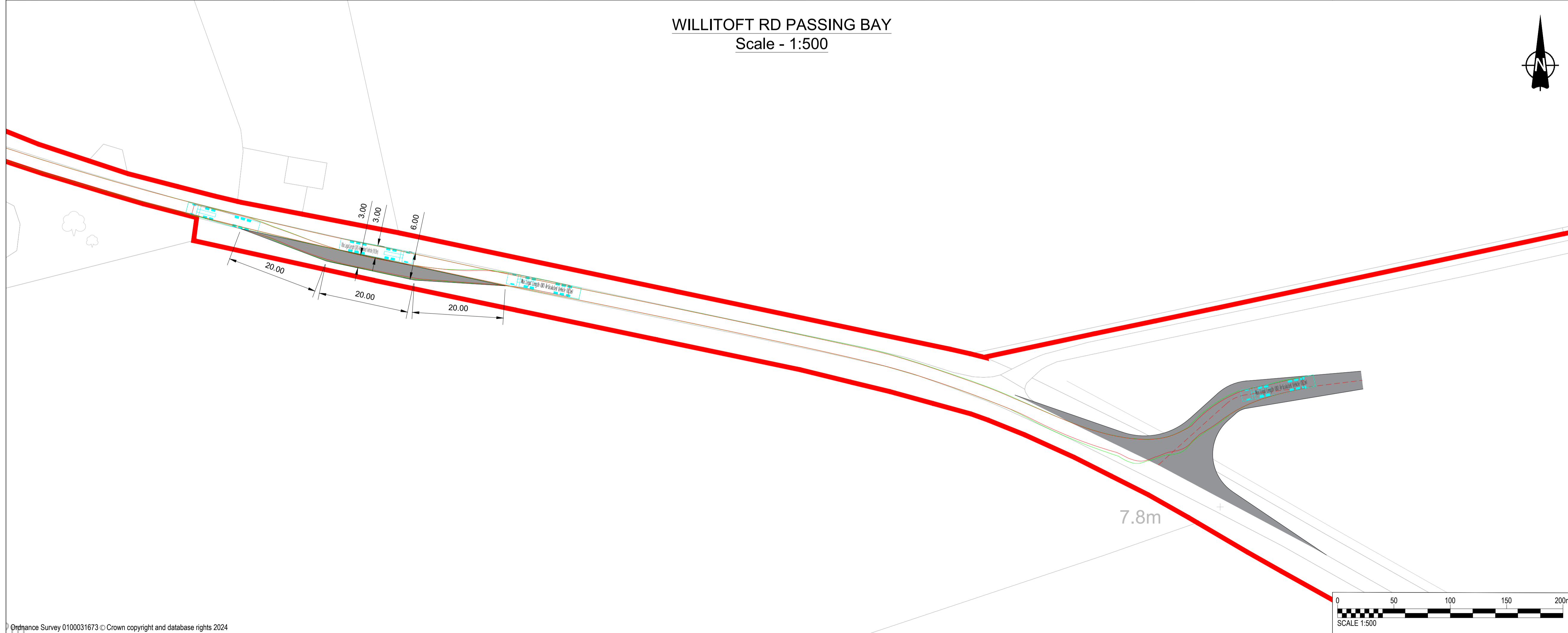

- GENERAL NOTES**
1. This drawing is to be read in conjunction with all other relevant documentation.
 2. Do not scale from this drawing, use only printed dimensions.
 3. All dimensions in metres, all chainages, levels and coordinates are in metres unless defined otherwise.
 4. This Drawing is to be read in conjunction with the project health & Safety File for any identified potential risks.
 5. For details of access into access 1 please refer to drawing number 60686115-HGN-DR-CH-0101

KEY

- Red Line Boundary
- Existing Public Rights of Way
- Vehicle body
- Vehicle body path
- Vehicle load
- Vehicle load path
- Vehicle wheels path
- Edge of road
- Land not included in the Order Limits
- Extent of passing bay

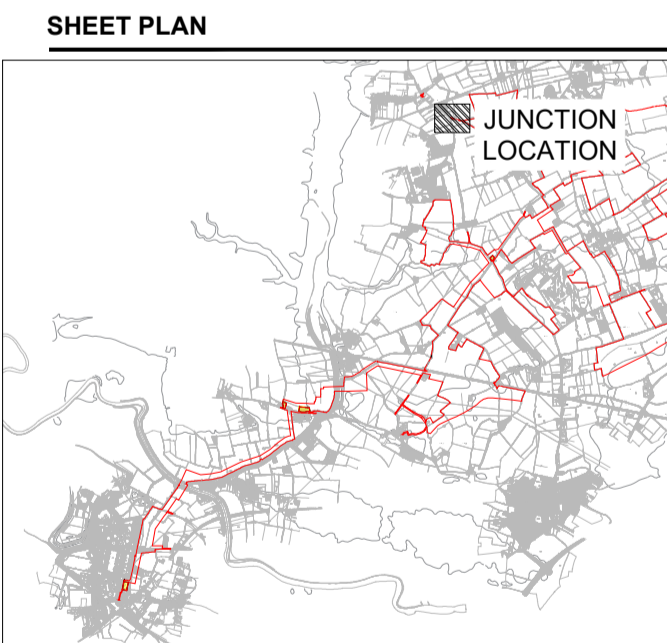

ISSUE/REVISION

NO	DATE	DESCRIPTION
P02	11/04/2024	Updated drawing notes
P01	04/04/2024	Issued for internal review
I/R	DATE	DESCRIPTION

This drawing has been prepared for the use of AECOM's client. It may not be used, modified, reproduced or relied upon by third parties, except as agreed by AECOM or as required by law. AECOM accepts no responsibility, and denies any liability whatsoever, to any party that uses or relies on this drawing without AECOM's express written consent. Do not scale this document.

PROJECT

East Yorkshire Solar Farm
Development Consent Order

CLIENT

East Yorkshire Solar Farm Limited

CONSULTANT

AECOM
Saxon House, 27 Duke Street
Chelmsford, Essex, CM1 1HT
01245 771200 tel 01245 476121 fax
www.aecom.com

GENERAL NOTES

1. This drawing is to be read in conjunction with all other relevant documentation.
2. Do not scale from this drawing, use only printed dimensions.
3. All dimensions in metres, all chainages, levels and coordinates are in metres unless defined otherwise.
4. This Drawing is to be read in conjunction with the project health & Safety File for any identified potential risks.
5. Location of passing bays selected to compliment the horizontal geometry of the existing carriageway and to seek to minimise any environmental impacts.

KEY

- Red Line Boundary
- Existing Public Rights of Way
- Vehicle body path
- Vehicle load path
- Vehicle load
- Vehicle wheels path
- Edge of road
- Land not included in the Order Limits
- Extent of passing bay
- Forward visibility (150m)
- Rearward visibility (150m)

SHEET PLAN

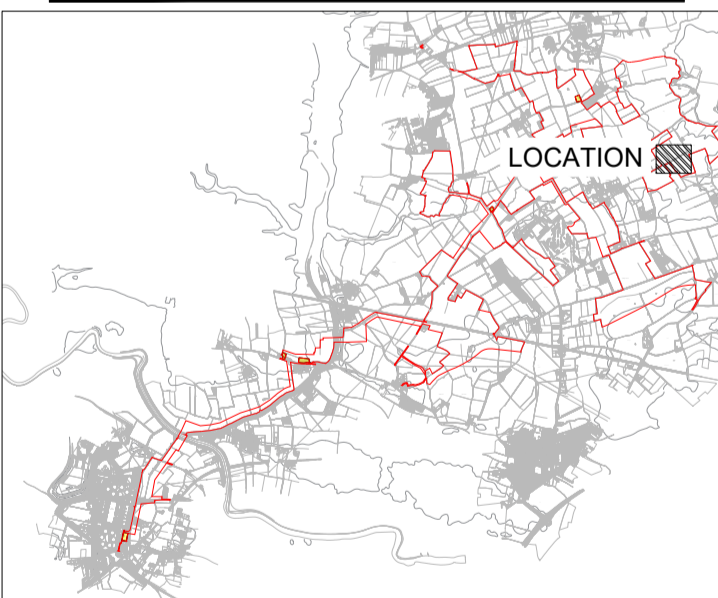

ISSUE/REVISION

NO	DATE	DESCRIPTION
P02	28/06/2024	Additional passing bay added
P01	04/04/2024	Issued for internal review
I/R	DATE	DESCRIPTION

PROJECT NUMBER

60686115

SHEET TITLE

INGS LANE
SWEEP PATH ANALYSIS AND
PASSING PLACE STRATEGY

SHEET NUMBER

60686115-HGN-DR-CH-0145

INGS LANE PASSING BAY
Scale - 1:2000

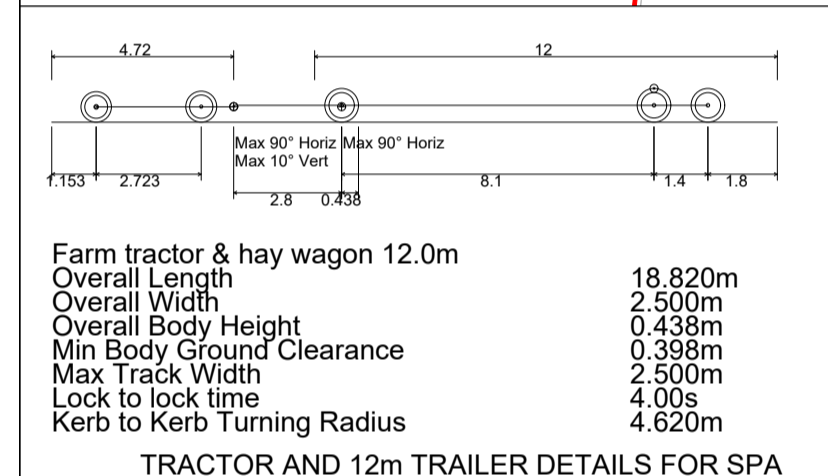
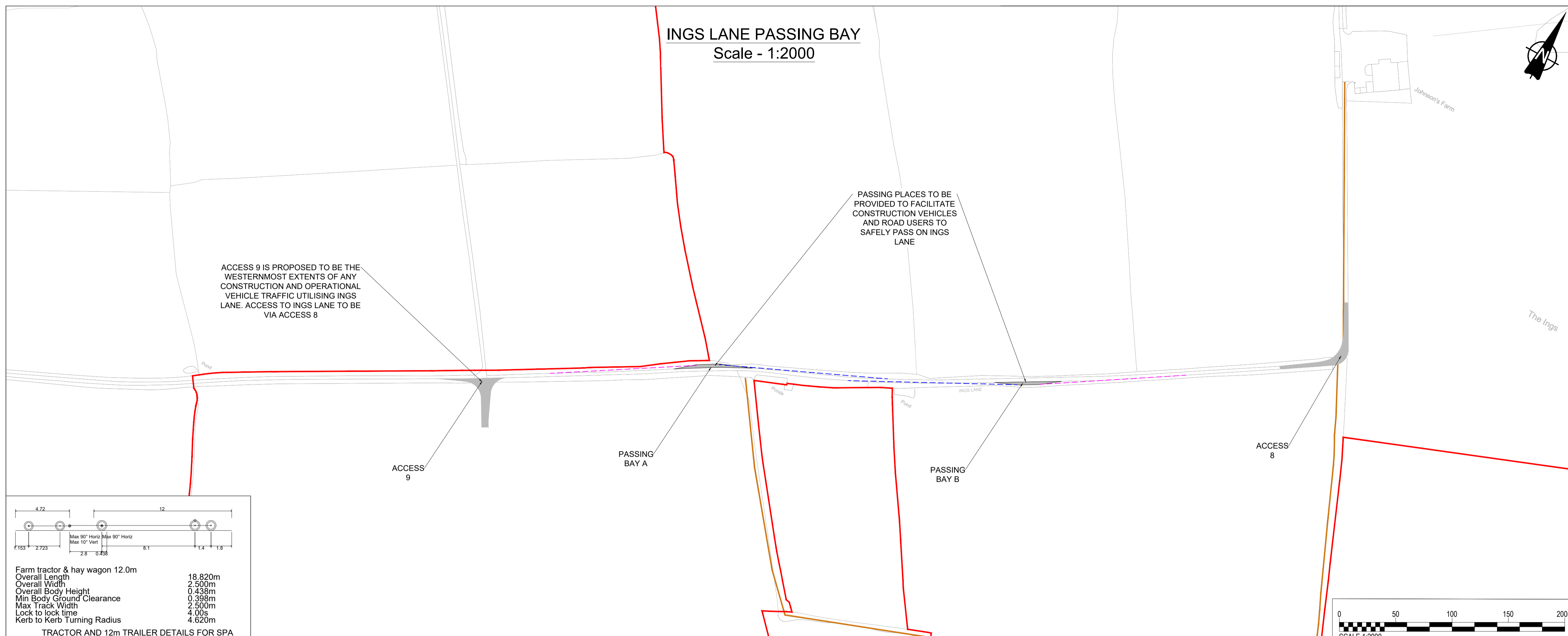

INGS LANE PASSING BAY A
Scale - 1:500

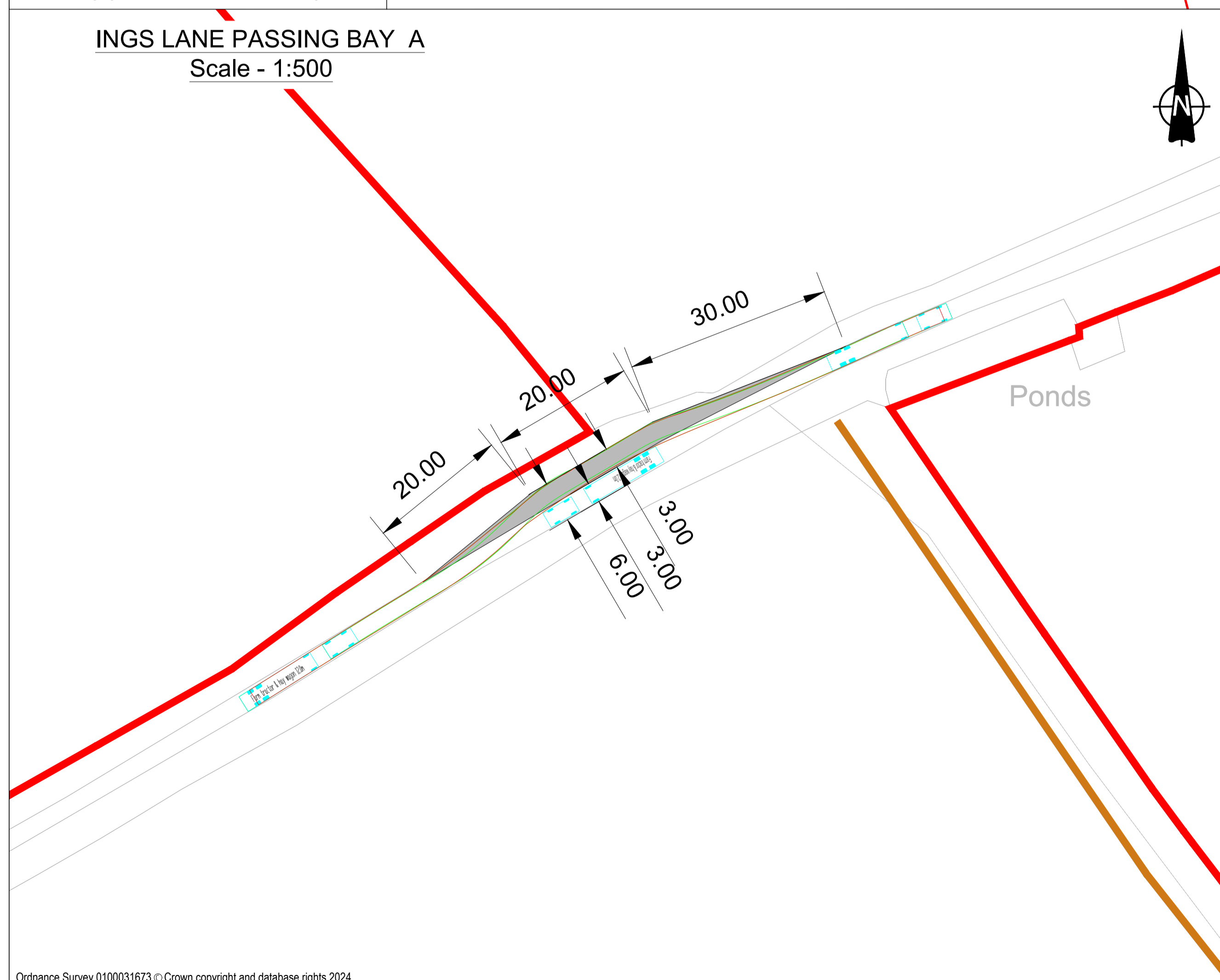

INGS LANE PASSING BAY B
Scale - 1:500

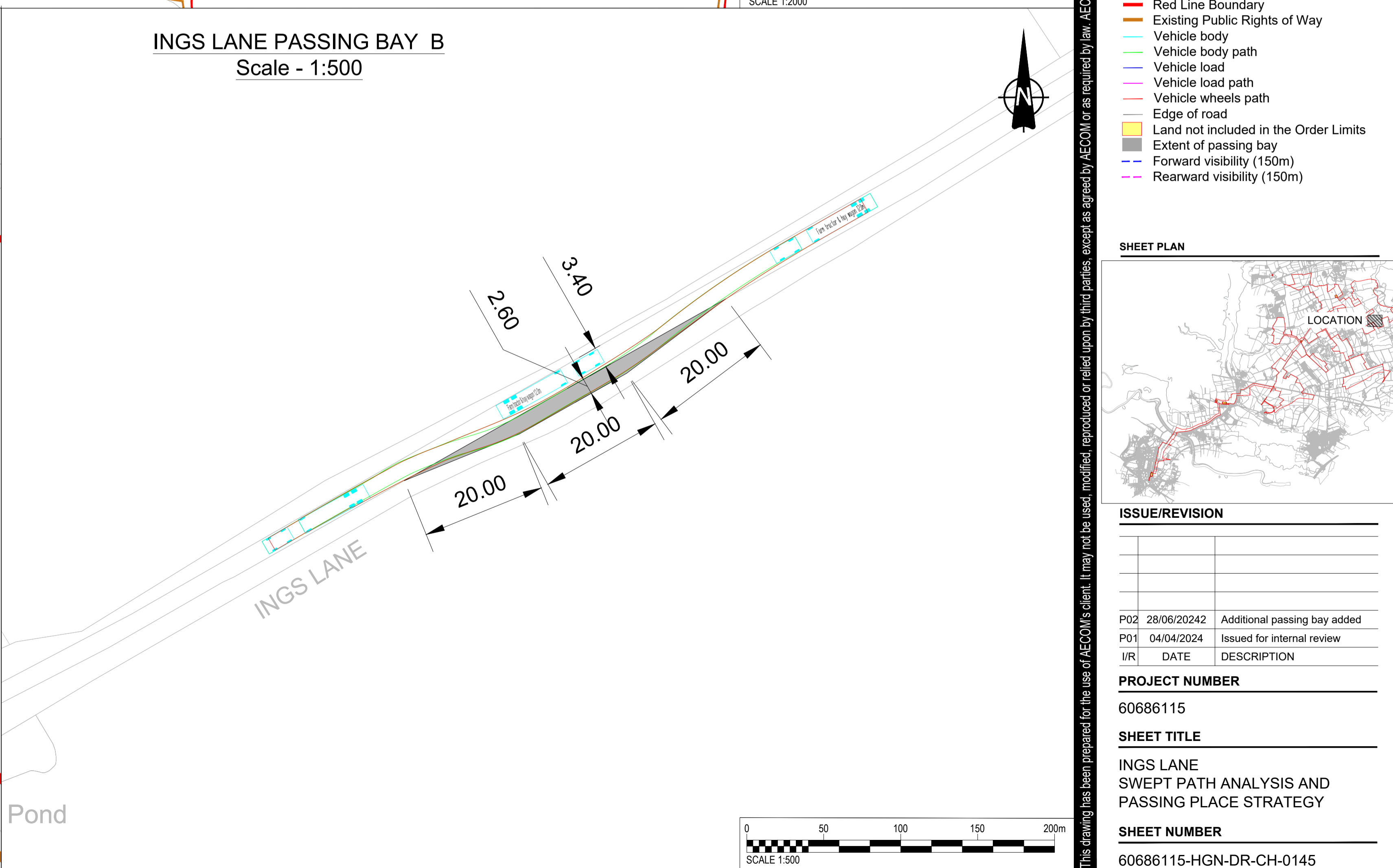

This drawing has been prepared for the use of AECOM's client. It may not be used, modified, reproduced or relied upon by third parties, except as agreed by AECOM or as required by law. AECOM accepts no responsibility, and denies any liability whatsoever, to any party that uses or relies on this drawing without AECOM's express written consent. Do not scale this document.

- GENERAL NOTES**
1. This drawing is to be read in conjunction with all other relevant documentation.
 2. Do not scale from this drawing, use only printed dimensions.
 3. All dimensions in metres, all chainages, levels and coordinates are in metres unless defined otherwise.
 4. This Drawing is to be read in conjunction with the project health & Safety File for any identified potential risks.
 5. Location of passing bays selected to compliment the horizontal geometry of the the existing carriageway and to seek to minimise any environmental impacts.

WOOD LANE PASSING BAY

Scale - 1:5000

PASSING PLACES TO BE PROVIDED TO FACILITATE CONSTRUCTION VEHICLES AND ROAD USERS TO SAFELY PASS ON WOOD LANE

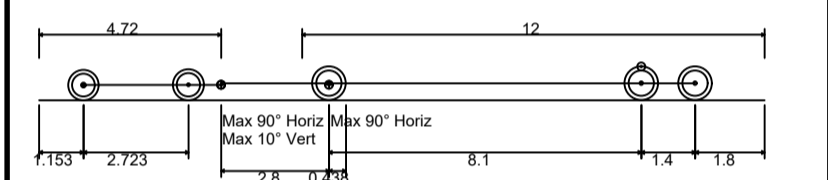
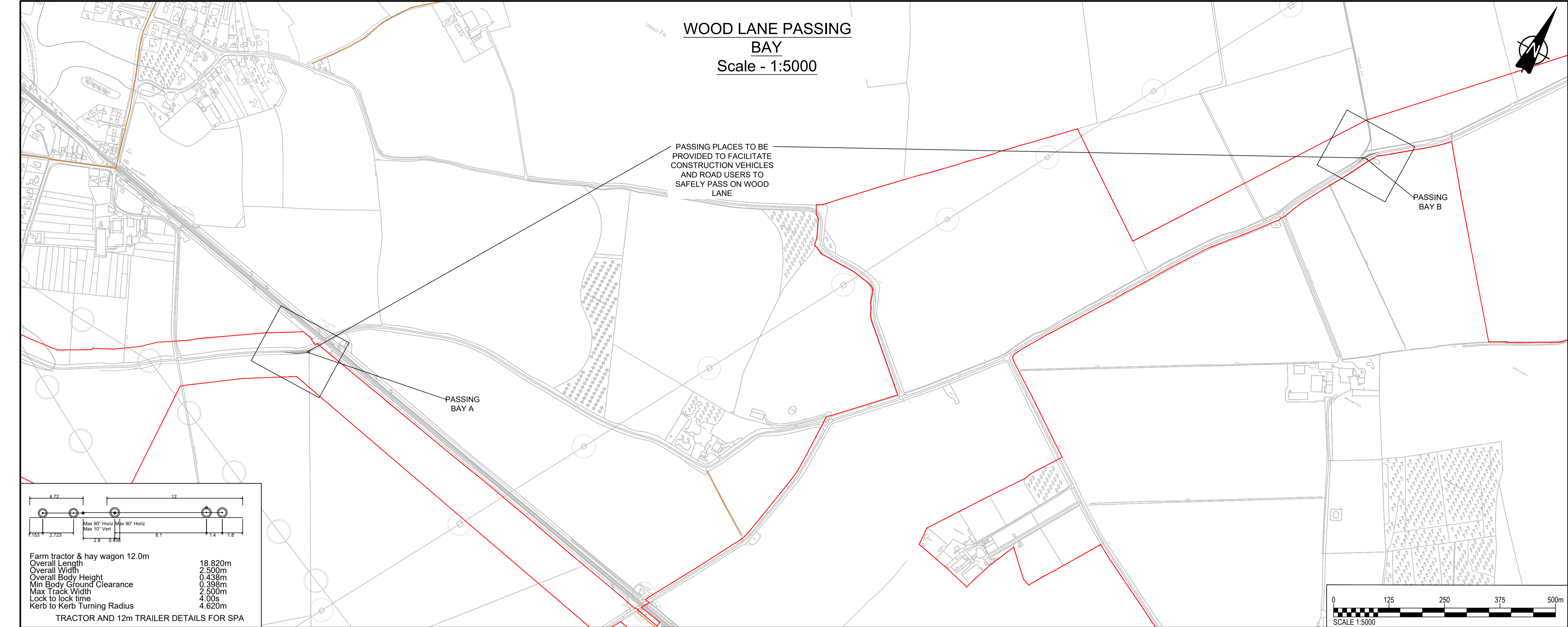

Farm tractor & hay wagon 12.0m

Overall Length	18.820m
Overall Width	2.500m
Overall Body Height	0.438m
Min Body Ground Clearance	0.398m
Max Track Width	2.500m
Lock to lock time	4.00s
Kerb to Kerb Turning Radius	4.620m

TRACTOR AND 12m TRAILER DETAILS FOR SPA

WOOD LANE PASSING BAY A

Scale - 1:500

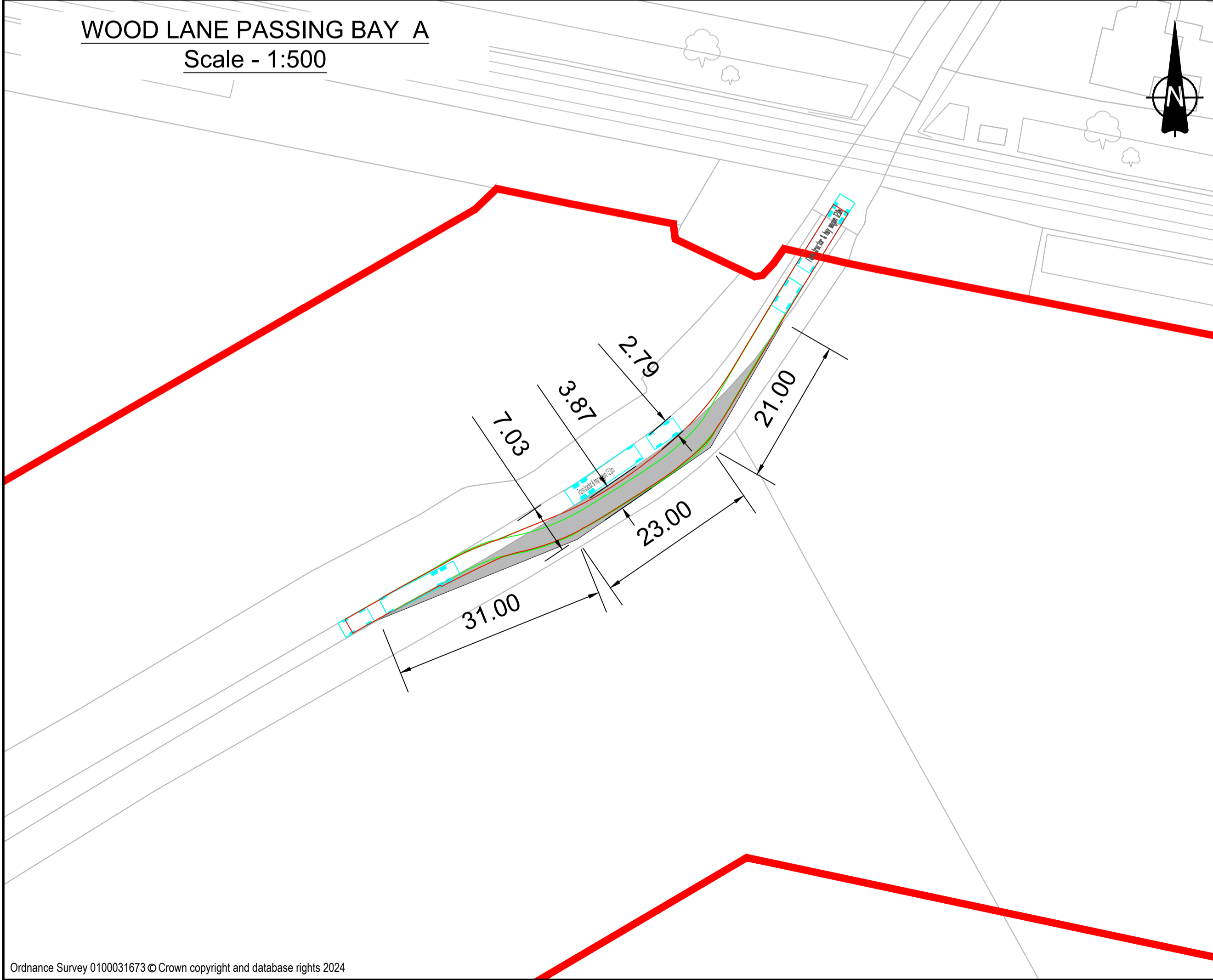

WOOD LANE PASSING BAY B

Scale - 1:500

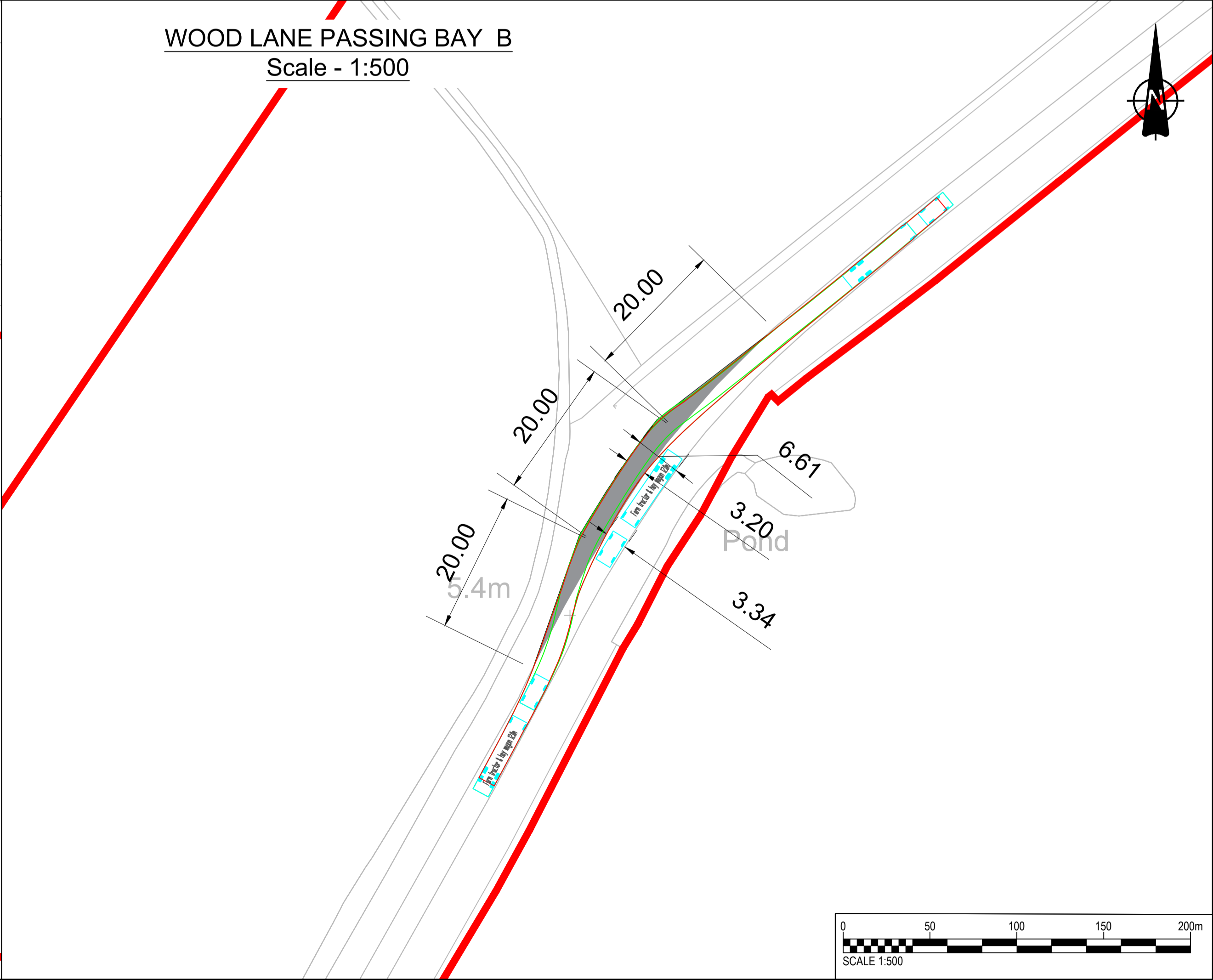

- KEY**
- Red Line Boundary
 - Existing Public Rights of Way
 - Vehicle body path
 - Vehicle body path
 - Vehicle load path
 - Vehicle load path
 - Vehicle wheels path
 - Edge of road
 - Land not included in the Order Limits
 - Extent of passing bay

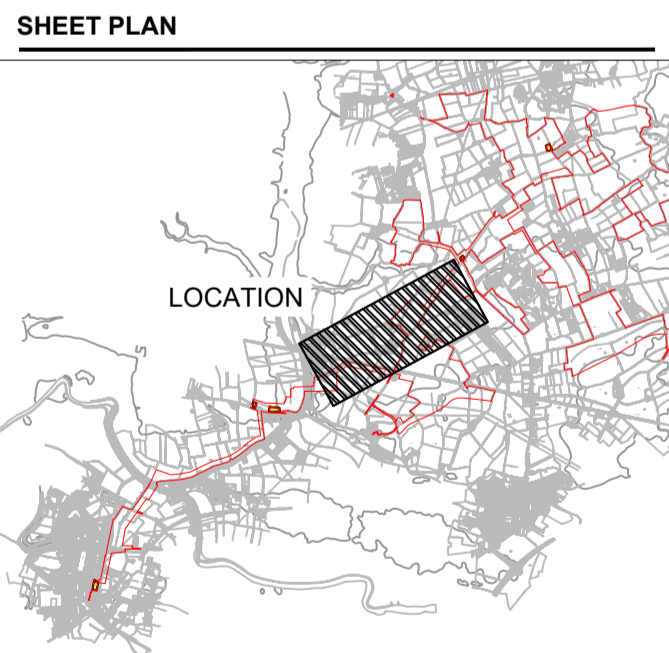

ISSUE/REVISION

NO	DATE	DESCRIPTION
P01	21/08/2024	Issued for internal review
I/R	DATE	DESCRIPTION

PROJECT NUMBER
60686115

SHEET TITLE
WOOD LANE
SWEEP PATH ANALYSIS AND
PASSING PLACE STRATEGY

SHEET NUMBER
60686115-HGN-DR-CH-0146

ISO A1 594mm x 841mm
 Approved: JCH
 Checked: MP
 Designer: KP
 Project Management Initials:
 Last saved by: KYLE BLACKETT (2024.08.21) Last Plotted: 2024.08.30
 Filename: C:\USERS\JAMES.HEMINGWAY\ONEDRIVE - AECOM\ESF - HIGHWAYS CAD\DRAWINGS (CAD)\60686115-HGN-DR-CH-0146.DWG
 Ordnance Survey 0100031673 © Crown copyright and database rights 2024

This drawing has been prepared for the use of AECOM's client. It may not be used, modified, reproduced or relied upon by third parties, except as agreed by AECOM or as required by law. AECOM accepts no responsibility, and denies any liability whatsoever, to any party that uses or relies on this drawing without AECOM's express written consent. Do not scale this document.